



# SITEMANAGER

QUICK INSTALLATION

# EN



## device overview

### Characteristics



- 19 “mounting frame for use in common server racks
- Professional device for active control of building infrastructures
- SITEMANAGER 7 natively supports over 1300 different UPS models and can therefore manage almost any UPS device with a compatible protocol system.
- BACS battery management integrated into the device

### product features

- 2x RJ10 for BACS battery bus for up to 500 batteries
- 8 freely definable digital NC / NO inputs
- 8 analogue inputs (0 - 10 V, 4 - 20 mA, 0 - 20 mA, (configurable via jumper)
- 8 relay outputs (switching, max. 230VAC / 4A or 48VDC / 1A)
- Timer and scheduler for planned output controls
- Definable presetting of the outputs at system startup.
- 10 / 100 / 1000Mbit network connection
- RS-232 interface for connecting a UPS
- Modern and slim web interface guarantees fast and intuitive system configuration
- Supported protocols and functions:

MODBUS / IP, IPv6, HTTP, HTTPS, SMTP, NTP, sFTP, UPSTCP (UNMS 2), BACnet /IP, Syslog / Remote Syslog, SNMP v1,2,3

- Battery-backed real-time clock and automatic synchronization with time servers.
- LED alarm indicator, LED working status indicator.
- Integrated email client.
- Non-volatile memory for alarm data and measured value recording
- Integrated WLAN interface for flexible network access via cable / wireless

<b>Technical Data</b>	
Power Supply	24V (min. 18V, max. 75V DC)
Max. Power Consumption	40 watts
Size (W x L x H), Weight	483 x 162 x 44mm, 2262 g (483 x 212 x 44mm incl. SM_LOOM) 19.00 x 6.38 x 1.73in, 2262g (19.02 x 8.35 x 1.73in incl. SM_LOOM)
Ethernet	10/100/1000 Mbit Base-T auto sense
RS-232 interface (MINIDIN 9-pin)	1
Wi-Fi	1 802.11N EW-7811Un V2 integrated Wi-Fi / 150 Mbit REALTEK RTL8188EU Chipset
Analog Inputs 0-10V, 4-20mA, 0-20mA	8
Digital Inputs	8
Relay Outputs (Max. 230VAC / 4A or 48VDC / 1A)	8
BACS Bus Connectors	2
USB service port for BACS	1
Status LEDs	Back panel: normal (green), boot/error (red) Front panel: power (green) BACS status (green/yellow), state LEDs for inputs, outputs, alarms
User Guide	English, German
MIB	RFC 1628 and private extensions BACS MIB extensions
Operating Temperature	0 – 45 °C
Storage Temperature	0 – 70 °C
Max. Recommended Ambient Temperature	45 °C
processing unit	ARMCortex A8 800 MHz
Flash Memory	8GB
RAM.	512 MB
Humidity	20-95%, not condensing
Warranty	2 years

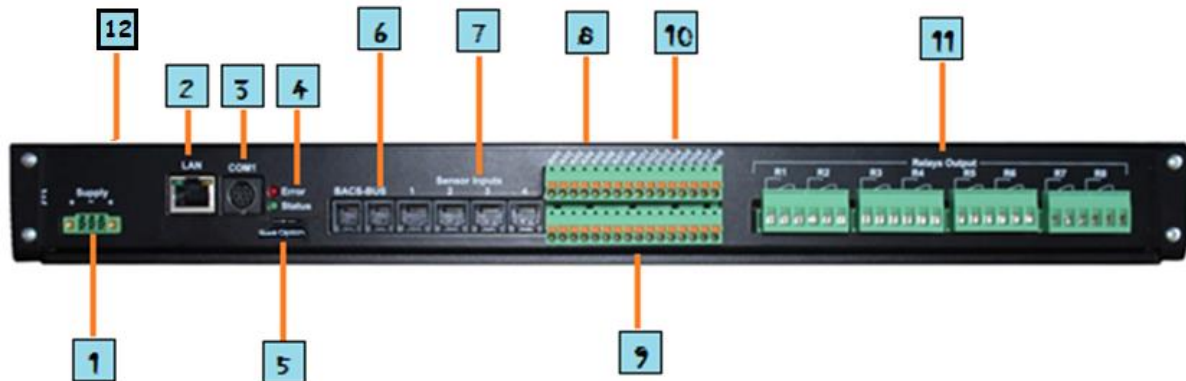
**SITEMANAGER 7 connections:****Back / internal:**

1. power connection
2. LAN connection 10/100/1000 Mbit Base-T auto sense
3. COM port for connecting a UPS
4. Status LEDs: ERROR / System
5. selecting the operating mode
6. BACS bus connection
7. connection for analogue sensors
8. Terminal connections for third-party analogue sensors
9. Internal power connection for external sensors.
10. Digital inputs
11. relay contacts
12. Integrated 802.11n Wi-Fi 150 MBit

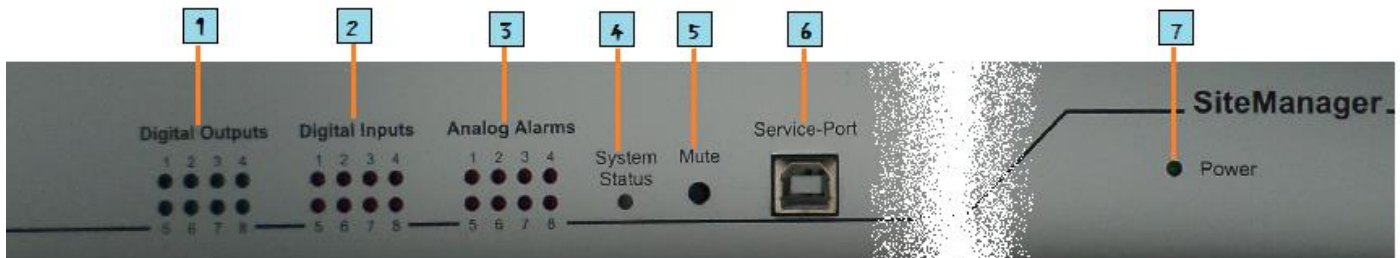
**Front:**

1. LED display: Active digital outputs
2. LED display: Active digital inputs
3. LED display: Analog sensor input
4. LED: General alarm status
5. Switch: Mute/pause internal alarm
6. USB service port for BACS.
7. LED: Operating display and current boot status

**Checklist for initial installation**

*This is a suggested sequence for structured commissioning:*

1. Putting SITEMANAGER 7 into operation
2. Connect LAN, UPS and sensors
3. Final installation of sensors and actuators on site, note cable lengths
4. Setting the IP address
5. operating mode check
6. Disconnect SITEMANAGER 7 from the power supply
7. Install SITEMANAGER 7 in the cabinet and put it back into operation

**Commissioning of SITEMANAGER 7**

The SITEMANAGER 7 offers flexible connection options to a power source.

As standard, the SITEMANAGER 7 is supplied with a 24 V / 1.5 A power supply and a coded power plug to avoid incorrect wiring. If required, an additional power supply can be connected as a redundant power supply.



The SITEMANAGER 7 is compatible with any independent power source that meets the following specifications:

Minimum: 18 VDC

Maximum: 75 VDC

**Connecting the UPS to the SITEMANAGER 7**

On the back of the device, next to the network port with COM 1, there is a MINI DIN port:



Connect the supplied MINIDIN / RS232 adapter cable and then connect the standard data cable supplied with your UPS to the adapter cable.

Make sure that the connectors are firmly screwed together with the nuts provided. You will set the UPS model accordingly later in the configuration menu in SITEMANAGER 7:

**System Setup Wizard**

General   Network   Date & Time   **UPS Setup**   Review

**Model**  

**UPS ID**  

**Battery Installation Date**

**Tip:**

"No UPS Model defined" is used if you have not selected a UPS – in this case, default settings for a UPS dummy are loaded, which does not allow any conclusions to be drawn about the status of the currently connected UPS.

**IP and network settings**

All devices in the CS141 product family use these IP address settings when they are started for the first time:

IP            10.10.10.10  
Subnet:      255.255.255.0

The slide switch is set to the left position by default. As soon as you change the IP address, the device restarts and then uses the IP address you entered.

With the slide switch you can influence the following basic settings on the hardware side:

<p><b>slide switch in the middle position</b></p> <p>The device always starts with the hardware-set IP address 10.10.10.10.</p> <p><b>slide switch to the right</b></p> <p>DHCP mode activated by hardware. The device will ignore all manual IP address entries. A DHCP server must be accessible for this configuration.</p> <p><b>slide switch to the left</b></p> <p>In this mode, control of the network is given to the user. The user can freely decide whether to use a fixed IP address or use DHCP mode.</p>	
--	---

**Initial configuration of the Ethernet interface under 10.10.10.10****Preparation on a computer or laptop**

During initial setup and in configuration mode, the SITEMANAGER 7 can be accessed using the following IP settings:

IP address        10.10.10.10  
Subnet mask:    255.255.255.0

To access the SITEMANAGER 7 web interface, you must adjust your local IP address: We recommend the following configuration of your local network interface:

IP address:        10.10.10.11  
Subnet mask:    255.255.255.0  
Gateway          10.10.10.10  
DNS:              none

**Tip:**

If the slide switch is in the middle position, the CS141 will save all settings but ignore them until you have switched to manual operating mode on the hardware side. An overview of the configured and active network interfaces can be found under System>Network.

**The DHCP mode**

This mode requires an accessible DHCP server. In this mode, the SITEMANAGER 7 registers with the relevant DHCP server and asks for a corresponding IP address. The MAC address (Media Access Control) is automatically entered in the DHCP server and can be displayed there.

The MAC address of your SITEMANAGER 7 can be found on the bottom of the device.



**Quick configuration – the Setup Wizard**

For this configuration step you need the following menu

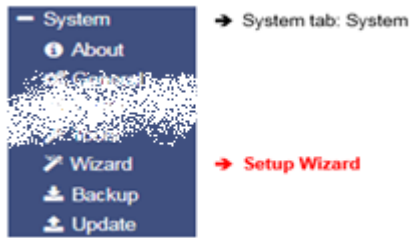

During the initial configuration, the Setup Wizard starts automatically, which guides you through the further configuration and requests all the basic settings that are necessary for further configuration:

The screenshot shows the 'System Setup Wizard' window. It has a title bar and a tabbed interface with 'General', 'Network', 'Date & Time', 'UPS Setup', and 'Review'. The 'General' tab is active. It contains several input fields: 'Location', 'System Contact', and 'Check Firmware Update' (with a checked checkbox). Below these is a 'Region' section with a 'Language' dropdown menu set to 'English' and 'Temperature' radio buttons for 'Celsius' (selected) and 'Fahrenheit'. At the bottom, there are 'Back', 'Next', and 'Cancel' buttons.

***general***

Basic settings about location, contact information for responsible personnel, system language and temperature

***Network***

Basic settings such as IP address, subnet mask, etc. The necessary data is managed by the responsible administrator of the target network.

***Date & Time***

Basic settings about time, time zone and time server

***UPS Setup***

If available, the connected UPS is set here

***review***

Overview of all entries. If you want to make a change, you can call up the menu using the “Back” function.

**Tip:**

The Setup Wizard is a tool to get SITEMANAGER 7 up and running as quickly as possible.

The Setup Wizard only asks for basic information and then automatically configures your SITEMANAGER 7 – If you have carried out further configurations, these could be deleted by calling it again.

**WLAN / Wi-Fi**

The integrated Wi-Fi interface is deactivated by default.

To set up a Wi-Fi connection, proceed as follows:

1. Open the Wi-Fi settings under System>Network>Wi-Fi
2. For IP Configuration, change the setting from “Disabled” to “DHCP”.
3. Under Network Name, enter the SSID you want to reach.
4. Under Password, enter the password for the WLAN you want to log into.
5. Click Apply to apply the setting.

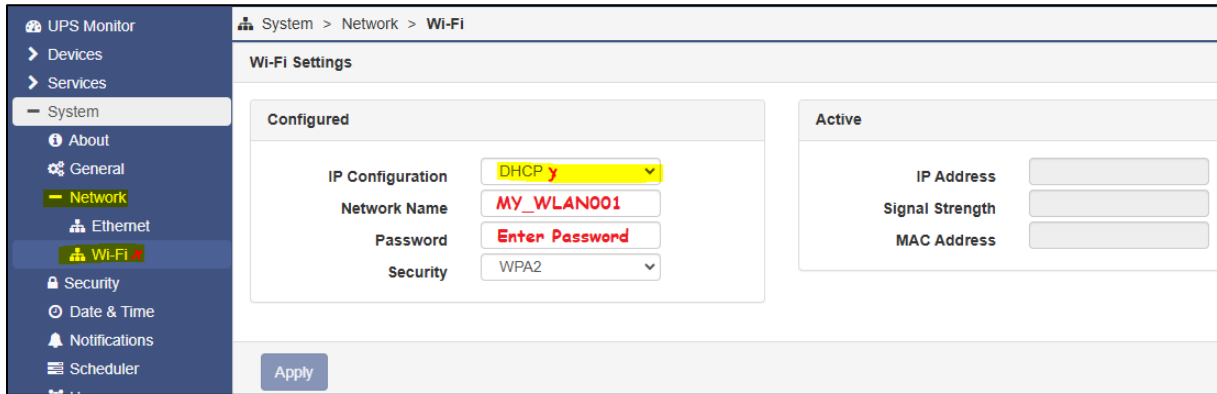

The SITEMANAGER automatically connects to the WLAN and displays its IP address under Active on the right side, via which the SITEMANAGER web interface can also be accessed.

**Tip:**

***If you do not want to use Wi-Fi, disable the feature by changing the DHCP setting to Disabled.***

**SITEMANAGER 7 - GENEREX Sensors / 3rd Party Sensors**

The SITEMANAGER 7 offers connections for GENEREX sensors as well as the option of connecting external sensors via a terminal block. If you do not want to use the terminal block, it can be removed using a suitable tool.

Please note that you can use either the RJ-11 sockets OR your own analogue connection cables. The analogue inputs can be configured to input signals with 0-10V or 0 / 4-20mA.

The internal power source supplies the necessary operating voltage for up to 8 sensors if required.

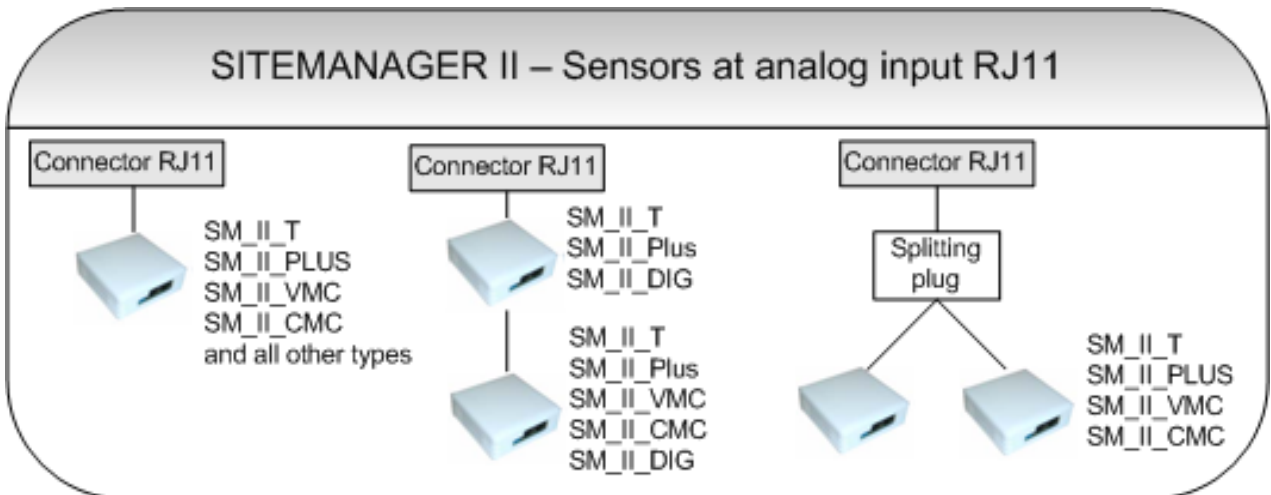



**relays and relay contacts**

The SITEMANAGER 7 offers 8 power relays that can relate to up to 250V / 4A.

Each relay offers both Normally Closed and Normally Open connection options. The following circuit diagram shows the contact assignment:

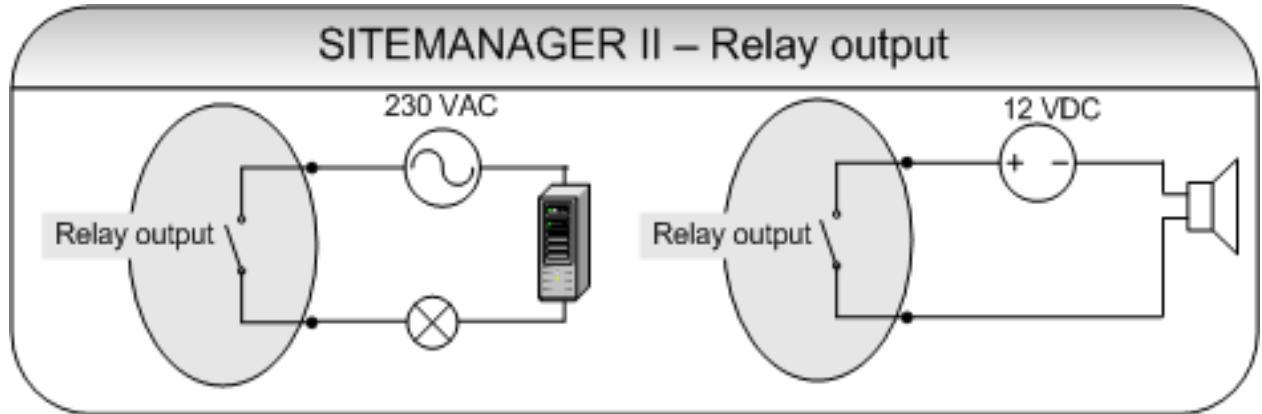
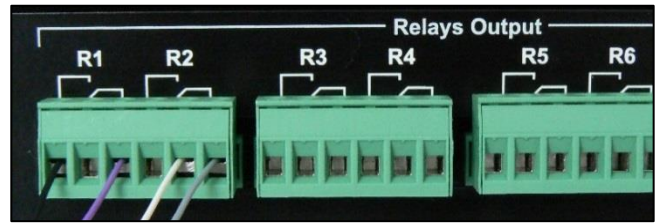

**Digital and analogue connections**

The upper terminal block is the digital (DIG) and analogue (AN) inputs. The lower terminal block provides additional power for sensors and Actuators:

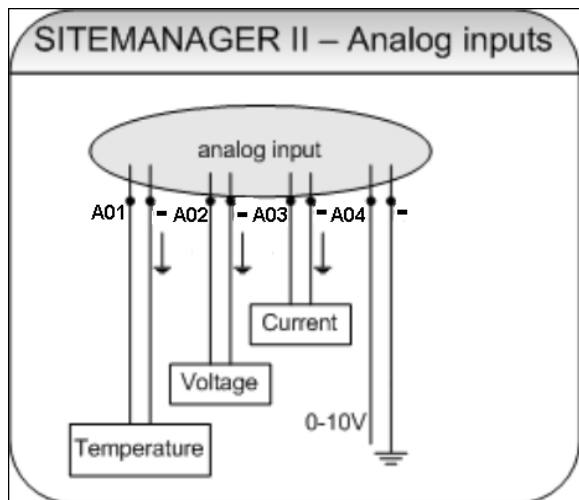
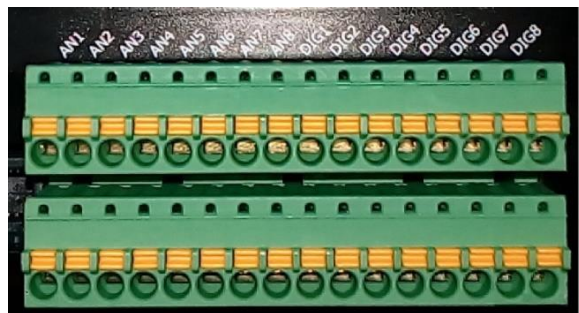

Terminal designation:	Connection type:
X1 / 12V +	operating voltage +12VDC
X1 / -	GND -
X2/A01	Analog Input 1
X2/A02	Analog Input 2
X2/A03	Analog Input 3
X2/A04	Analog Input 4
X2/A05	Analog Input 5
X2/A06	Analog Input 6
X2/A07	Analog Input 7
X2/A08	Analog Input 8
X2/D01	Digital Input 1
X2/D02	Digital Input 2
X2/D03	Digital Input 3
X2/D04	Digital Input 4
X2/D05	Digital Input 5
X2/D06	Digital Input 6
X2/D07	Digital Input 7
X2/D08	Digital Input 8

### SITEMANGER II - Digital Inputs

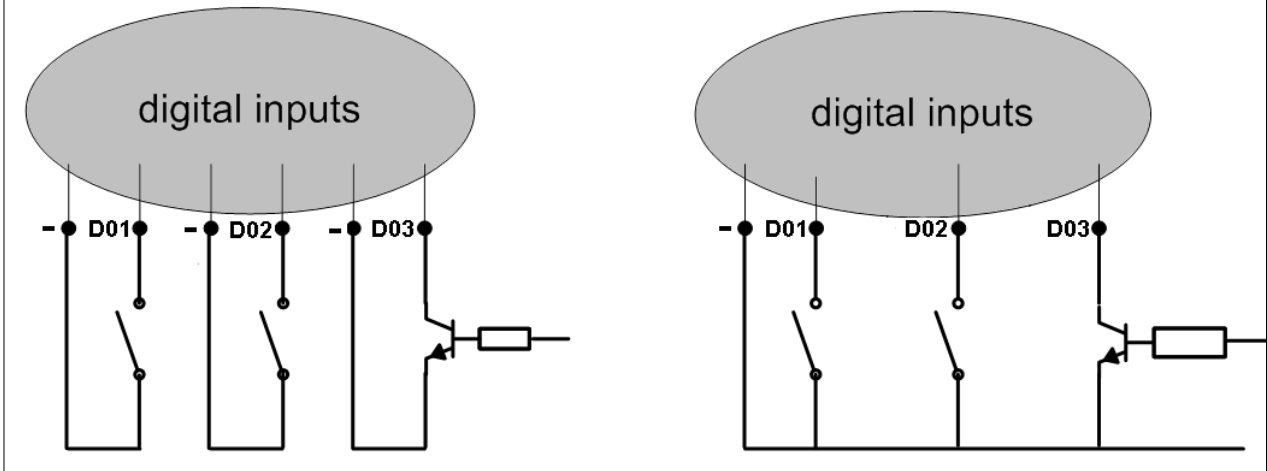

---

**GENEREX**